











































Modelo	Canais	MSO	Largura de banda	Taxa de amostragem	Mem.	Res .	GS.	AWG	Alimentação USB	Preço sem IVA
 PicoScope 2204A	2		10 MHz	100 MS/s	8 kS	8	SIM	SIM	SIM	€119.00
 PicoScope 2205A	2		25 MHz	200 MS/s	16 kS	8	SIM	SIM	SIM	€189.00
 PicoScope 2206B	2		50 MHz	500 MS/s	32 MS	8	SIM	SIM	SIM	€299.00
 PicoScope 2205A MSO	2	SIM	25 MHz	500 MS/s	48 kS	8	SIM	SIM	SIM	€389.00
 PicoScope 2405A	4		25 MHz	500 MS/s	48 kS	8	SIM	SIM	SIM	€389.00
 PicoScope 2207B	2		70 MHz	1 GS/s	64 MS	8	SIM	SIM	SIM	€419.00
 PicoScope 3203D	2		50 MHz	1 GS/s	64 MS	8	SIM	SIM	SIM	€489.00
 PicoScope 2406B	4		50 MHz	1 GS/s	32 MS	8	SIM	SIM	SIM	€509.00







Modelo	Canais	MSO	Largura de banda	Taxa de amostragem	Mem.	Res .	GS.	AWG	Alimentação USB	Preço sem IVA
 PicoScope 2206B MSO	2	SIM	50 MHz	1 GS/s	32 MS	8	SIM	SIM	SIM	€519.00
 PicoScope 2208B	2		100 MHz	1 GS/s	128 MS	8	SIM	SIM	SIM	€579.00
 PicoScope 3204D	2		70 MHz	1 GS/s	128 MS	8	SIM	SIM	SIM	€629.00
 PicoScope 2207B MSO	2	SIM	70 MHz	1 GS/s	64 MS	8	SIM	SIM	SIM	€649.00
 PicoScope 4224	2		20 MHz	80 MS/s	32 MS	12	NÃO	NÃO	SIM	€699.00
 PicoScope 3203D MSO	2	SIM	50 MHz	1 GS/s	64 MS	8	SIM	SIM	SIM	€699.00
 PicoScope 2407B	4		70 MHz	1 GS/s	64 MS	8	SIM	SIM	SIM	€699.00







Modelo	Canais	MSO	Largura de banda	Taxa de amostragem	Mem.	Res .	GS.	AWG	Alimentação USB	Preço sem IVA
 PicoScope 3403D	4		50 MHz	1 GS/s	64 MS	8	SIM	SIM	SIM	€769.00
 PicoScope 4224 IEPE	2		20 MHz	80 MS/s	32 MS	12	NÃO	NÃO	SIM	€839.00
 PicoScope 3204D MSO	2	SIM	70 MHz	1 GS/s	128 MS	8	SIM	SIM	SIM	€839.00
 PicoScope 3205D	2		100 MHz	1 GS/s	256 MS	8	SIM	SIM	SIM	€839.00
 PicoScope 2208B MSO	2	SIM	100 MHz	1 GS/s	128 MS	8	SIM	SIM	SIM	€849.00
 PicoScope 2408B	4		100 MHz	1 GS/s	128 MS	8	SIM	SIM	SIM	€949.00
 PicoScope 5242A	2		60 MHz	1 GS/s	16 MS	16	SIM	NÃO	SIM	€979.00







Modelo	Canais	MSO	Largura de banda	Taxa de amostragem	Mem.	Res .	GS.	AWG	Alimentação USB	Preço sem IVA
 PicoScope 3403D MSO	4	SIM	50 MHz	1 GS/s	64 MS	8	SIM	SIM	SIM	€979.00
 PicoScope 3404D	4		70 MHz	1 GS/s	128 MS	8	SIM	SIM	SIM	€979.00
 PicoScope 4262	2		5 MHz	10 MS/s	16 MS	16	SIM	SIM	SIM	€1,045.00
 PicoScope 3205D MSO	2	SIM	100 MHz	1 GS/s	256 MS	8	SIM	SIM	SIM	€1,045.00
 PicoScope 4444	4		20 MHz	400 MS/s	256 MS	14	NÃO	NÃO	SIM	€1,085.00
 PicoScope 4424	4		20 MHz	80 MS/s	32 MS	12	NÃO	NÃO	SIM	€1,115.00
 PicoScope 5242B	2		60 MHz	1 GS/s	32 MS	16	SIM	SIM	SIM	€1,115.00

Modelo	Canais	MSO	Largura de banda	Taxa de amostragem	Mem.	Res .	GS.	AWG	Alimentação USB	Preço sem IVA
 PicoScope 3404D MSO	4	SIM	70 MHz	1 GS/s	128 MS	8	SIM	SIM	SIM	€1,185.00
 PicoScope 3206D	2		200 MHz	1 GS/s	512 MS	8	SIM	SIM	SIM	€1,185.00
 PicoScope 5243A	2		100 MHz	1 GS/s	64 MS	16	SIM	NÃO	SIM	€1,255.00
 PicoScope 5442A	4		60 MHz	1 GS/s	16 MS	16	SIM	NÃO	SIM	€1,325.00
 PicoScope 3405D	4		100 MHz	1 GS/s	256 MS	8	SIM	SIM	SIM	€1,325.00
 PicoScope 3425	4		5 MHz	20 MS/s	512 kS	12	NÃO	NÃO	SIM	€1,375.00
 PicoScope 5243B	2		100 MHz	1 GS/s	128 MS	16	SIM	SIM	SIM	€1,395.00

Modelo	Canais	MSO	Largura de banda	Taxa de amostragem	Mem.	Res	GS.	AWG	Alimentação USB	Preço sem IVA
 PicoScope 3206D MSO	2	SIM	200 MHz	1 GS/s	512 MS	8	SIM	SIM	SIM	€1,395.00
 PicoScope 5244A	2		200 MHz	1 GS/s	256 MS	16	SIM	NÃO	SIM	€1,535.00
 PicoScope 5442B	4		60 MHz	1 GS/s	32 MS	16	SIM	SIM	SIM	€1,535.00
 PicoScope 3405D MSO	4	SIM	100 MHz	1 GS/s	256 MS	8	SIM	SIM	SIM	€1,535.00
 PicoScope 5244B	2		200 MHz	1 GS/s	512 MS	16	SIM	SIM	SIM	€1,675.00
 PicoScope 5443A	4		100 MHz	1 GS/s	64 MS	16	SIM	NÃO	SIM	€1,745.00
 PicoScope 3406D	4		200 MHz	1 GS/s	512 MS	8	SIM	SIM	SIM	€1,815.00

Modelo	Canais	MSO	Largura de banda	Taxa de amostragem	Mem.	Res .	GS.	AWG	Alimentação USB	Preço sem IVA
 PicoScope 4824	8		20 MHz	80 MS/s	256 MS	12	SIM	SIM	SIM	€1,955.00
 PicoScope 5443B	4		100 MHz	1 GS/s	128 MS	16	SIM	SIM	SIM	€1,955.00
 PicoScope 3406D MSO	4	SIM	200 MHz	1 GS/s	512 MS	8	SIM	SIM	SIM	€2,025.00
 PicoScope 5444A	4		20 MHz	1 GS/s	256 MS	16	SIM	NÃO	SIM	€2,165.00
 PicoScope 5444B	4		200 MHz	1 GS/s	512 MS	16	SIM	SIM	SIM	€2,375.00
 PicoScope 6402C	4		250 MHz	5 GS/s	256 MS	8	SIM	NÃO	NÃO	€2,795.00
 PicoScope 6402D	4		250 MHz	5 GS/s	512 MS	8	SIM	SIM	NÃO	€3,495.00

Modelo	Canais	MSO	Largura de banda	Taxa de amostragem	Mem.	Res .	GS.	AWG	Alimentação USB	Preço sem IVA
 PicoScope 6403C	4		350 MHz	5 GS/s	512 MS	8	SIM	NÃO	NÃO	€4,195.00
 PicoScope 6403D	4		350 MHz	5 GS/s	1 GS	8	SIM	SIM	NÃO	€4,895.00
 PicoScope 6404C	4		500 MHz	5 GS/s	1 GS	8	SIM	NÃO	NÃO	€5,595.00
 PicoScope 6404D	4		500 MHz	5 GS/s	2 GS	8	SIM	SIM	NÃO	€6,295.00
 PicoScope 6407	4		1 GHz	5 GS/s	1 GS	8	SIM	SIM	NÃO	€8,395.00
 PicoScope 9301-15	2		15 GHz	1 MS/s	32 kS	16	SIM	NÃO	NÃO	€9,285.00
 PicoScope 9302-15	2		15 GHz	1 MS/s	32 kS	16	SIM	NÃO	NÃO	€11,455.00

Modelo	Canais	MSO	Largura de banda	Taxa de amostragem	Mem.	Res	GS.	AWG	Alimentação USB	Preço sem IVA
 PicoScope 9311-15	2		15 GHz	1 MS/s	32 kS	16	SIM	NÃO	NÃO	€12,135.00
 PicoScope 9301-25	2		25 GHz	1 MS/s	32 kS	16	SIM	NÃO	NÃO	€14,235.00
 PicoScope 9311-20	2		20 GHz	1 MS/s	32 kS	16	SIM	NÃO	NÃO	€16,915.00
 PicoScope 9302-25	2		25 GHz	1 MS/s	32 kS	16	SIM	NÃO	NÃO	€17,335.00
 PicoScope 9341-20	4		20 GHz	1 MS/s	32 kS	16	SIM	NÃO	NÃO	€19,955.00
 PicoScope 9341-25	4		25 GHz	1 MS/s	32 kS	16	SIM	NÃO	NÃO	€22,275.00

Modelo	Canais	MSO	Largura de banda	Taxa de amostragem	Mem.	Res	GS.	AWG	Alimentação USB	Preço sem IVA
 PicoScope 9321-20	2		20 GHz	1 MS/s	32 kS	16	SIM	NÃO	NÃO	€26,275.00

- MSO – Osciloscópio sinais mixtos.
- RES – Resolução.
- G.S – Gerador de sinais.
- AWG – Gerador de sinais arbitrário.

• PicoVNA 106 features PicoVNA 106

- The PicoVNA 106 Vector network analyzer
- PRICE

€5085

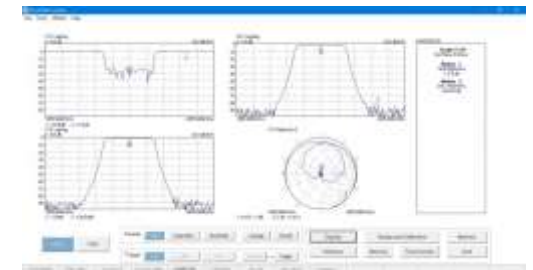
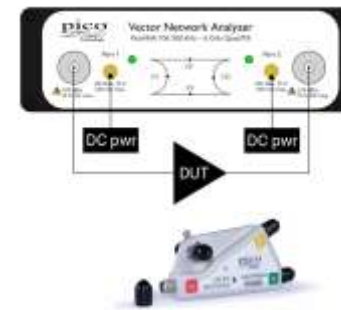

• 'Quad RX' four-receiver architecture

- In a VNA a swept sine-wave signal source is used to sequentially stimulate the ports of the interconnect or device under test. The amplitude and phase of the resultant transmitted and reflected signals appearing at both VNA ports are then received and measured. To wholly characterize a 2-port device under test (DUT), six pairs of measurements need to be made: the amplitude and phase of the signal that was emitted from both ports, and the amplitude and phase of the signal that was received at both ports for each source. In practice this can be achieved with a reasonable degree of accuracy with a single source, a transfer switch and two receivers; the latter inputs being switched through a further pair of transfer switches. Alternatively three receivers can be used with an additional input transfer switch or, as in the PicoVNA, four receivers can be used. Using four receivers eliminates the receiver input transfer switch errors (chiefly leakage and crosstalk) that cannot be corrected. These residual errors are always present in two- and three-receiver architectures and lead to lower accuracy than that of the Quad RX design.

(Preços mais IVA 23%)